

BỘ SƯU TẬP GẠCH KHÁNG KHUẨN 2022

Hygienic Tiles Collection



PRIME

Thịnh vượng là Prime



TIÊU DIỆT
LÊN TỚI **99,99%**

Vi khuẩn có hại (*)

(*) Đối với vi khuẩn E.coli. Trong điều kiện kiểm nghiệm.



ELIMINATE
UP TO **99,99%**

Harmful bacteria (*)

(*) Applied to E.coli. In testing conditions



LỜI MỞ ĐẦU

Trong những năm qua, xu hướng xây nhà và chọn lựa nguyên vật liệu làm nên tổ ấm của người Việt đã có những thay đổi rõ rệt. Bên cạnh nhu cầu về thẩm mỹ và công năng sử dụng, phương châm "sống sạch, sống khỏe" dần trở thành ưu tiên của nhiều gia đình.

Là một trong những nhà sản xuất hàng đầu trong ngành gạch ốp lát tại Việt Nam, Prime Group thấu hiểu điều đó và không ngừng đầu tư, nghiên cứu, phát triển để đáp ứng nhu cầu của người sử dụng. Bộ sưu tập Gạch kháng khuẩn của Prime Group ra đời với những thiết kế hiện đại, sự đột phá từ ứng dụng công nghệ Nano Bạc tiên tiến, giúp tiêu diệt lên tới 99,99% vi khuẩn có hại trên bề mặt gạch*.

Sử dụng gạch kháng khuẩn Prime không chỉ là sự lựa chọn hoàn hảo về thẩm mỹ mà còn là chuẩn mực mới cho phong cách sống hiện đại, an toàn.

(* Đối với vi khuẩn E.coli trong điều kiện kiểm nghiệm)

INTRODUCTION

Over the past few years, the way Vietnamese build and choose materials for houses has changed significantly. In addition to aesthetic and functional needs, the consumer trend is gradually shifting toward health, hygiene, and wellness.

As one of the leading manufacturers in Vietnam's ceramic tile industry, Prime Group understands that, and constantly invests, researches, and develops to meet the needs of users.

Prime Group's Hygienic tiles collection was born with modern designs, with a breakthrough from the application of advanced Nano Silver technology, which eliminates up to 99,99% of harmful bacteria on the tile surface.*

Using Prime Hygienic tiles is not only a perfect choice for aesthetics but also a new standard for a safe and modern lifestyle.

(* Applied to E.coli in testing conditions)

CƠ CHẾ HOẠT ĐỘNG - CÔNG NGHỆ NANO BẠC

HOW DOES IT WORK? - SILVER NANO TECHNOLOGY

Công nghệ Nano bạc được biết đến là một trong những công nghệ diệt khuẩn an toàn và hiệu quả nhất hiện nay. Nano bạc gồm các hạt phân tử bạc siêu nhỏ, giải phóng ra ion dương Ag+ và phá vỡ màng bảo vệ vi khuẩn khi chúng tiếp xúc. Các ion Ag+ tương tác với các nhóm Peptidoglican và ức chế khả năng vận chuyển oxy của chúng vào bên trong tế bào vi khuẩn, dẫn đến vi khuẩn bị tiêu diệt. Gạch kháng khuẩn Prime có lớp men bề mặt trộn Nano bạc, mang lại không gian sống an toàn, kháng khuẩn và đảm bảo vệ sinh tốt nhất cho người sử dụng

Nano Silver Technology is known as one of the most effective and safe antibacterial technologies today. Nano silver consists of microscopic silver particles, releasing Ag+ ion capable of destroying bacteria protection membrane as soon as they come in contact. Ag+ ions interact with the Peptidoglican groups and inhibit their ability to transport oxygen into the bacterial membrane, leading to the death of the bacteria. This contributes to form a hygienic and clean tiles surface.

 = **Vi khuẩn có hại**
Unhealthy bacteria

 = **Ion bạc**
Nano Ag+ Ion

 = **Phân tử Nano bạc**
Silver nano particles

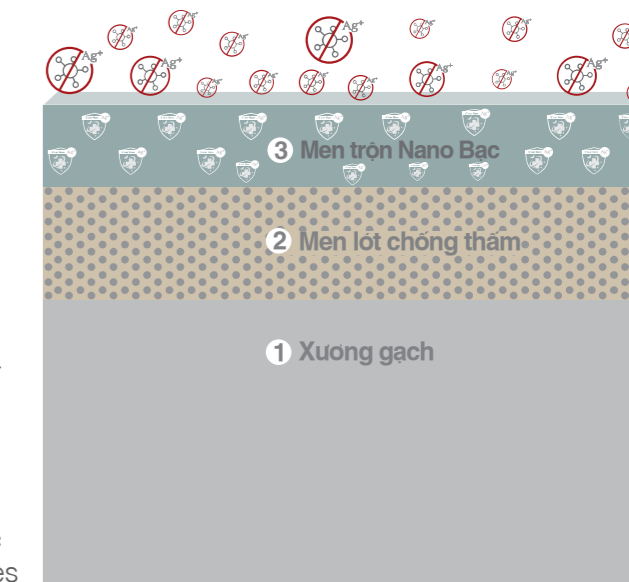

TIÊU DIỆT
LÊN TỚI **99,99%**

Vi khuẩn có hại (*)

(* Đối với vi khuẩn E.coli, trong điều kiện kiểm nghiệm.)



ELIMINATE
UP TO **99,99%**

Harmful bacteria (*)

(* Applied to E.coli, in testing conditions)

***Theo kết quả kiểm nghiệm cấp bởi SGS - Tiêu chuẩn ISO 22196:2011.**

SGS là công ty kiểm nghiệm, kiểm tra và chứng nhận hàng đầu thế giới.

***According to test results issued by SGS - ISO 22196:2011. SGS is the world's leading testing, inspection and certification company.**

(Vui lòng tham khảo kết quả kiểm nghiệm từ SGS ở trang 58
Please kindly see the test results from SGS for your reference on page 58)

04 LÝ DO

GẠCH KHÁNG KHUẨN PRIME LÀ SỰ LỰA CHỌN TỐT NHẤT CHO GIA ĐÌNH BẠN

REASONS
WHY
PRIME
HYGIENIC
TILES
ARE
THE
BEST
CHOICE
FOR
YOUR
FAMILY



TIÊU DIỆT ĐẾN 99,99% VI KHUẨN CÓ HẠI* / Eliminates up to 99,99% of harmful bacteria
**Đối với vi khuẩn E.coli trong điều kiện kiểm nghiệm*



TÍNH NĂNG DIỆT KHUẨN VỮNG BỀN SUỐT TUỔI THỌ MEN GẠCH** / Lifelong antibacterial ability
*** Phụ thuộc vào tình hình sử dụng thực tế*



KHOẢN ĐẦU TƯ TỐI ƯU / Optimal investment



MẪU MÃ ĐA DẠNG / Various designs



GIẢI PHÁP HOÀN HẢO CHO KHÔNG GIAN SỐNG ĐẸP VÀ AN TOÀN

Gạch kháng khuẩn Prime là lựa chọn tối ưu, mang lại bề mặt đảm bảo vệ sinh cho cả sàn và tường. Với công nghệ Nano Bạc tiên tiến, sản phẩm hoàn toàn không gây dị ứng hoặc kích ứng (so sánh với các sản phẩm diệt khuẩn thông thường). Thêm vào đó, mẫu mã đa dạng trên nhiều kích thước, với chất lượng đạt tiêu chuẩn quốc tế của Prime Group sẽ mang tới giải pháp thiết kế cho mọi không gian, từ bếp, phòng tắm, phòng khách, phòng ngủ, sảnh và các khu vực công cộng như trường học, bệnh viện, nhà hàng, khách sạn, trung tâm mua sắm.

PERFECT SOLUTION FOR A BEAUTIFUL AND SAFE LIVING SPACE

Prime Hygienic Tile is the optimal choice, providing a hygienic surface for both floors and walls. With advanced Nano Silver technology, the product is neither allergenic nor irritating (compared to normal sanitizing products). In addition, diverse designs in many sizes, with international quality standards of Prime Group will bring design solutions for every space, from the kitchen, bathroom, living room, bedroom, and lobby, to public areas such as schools, hospitals, restaurants, hotels, shopping malls.



MỤC LỤC / INDEX



Floor tiles

Gạch lát
Floor tiles



Wall tiles

Gạch ốp
Wall tiles



Glossy

Bề mặt bóng
Glossy



Matt

Bề mặt nhám
Matt



Polished

Mài bóng
Polished



Rectified

Mài cạnh
Rectified



Porcelain

Xương Porcelain
Porcelain



Structured

Ứng dụng khuôn định hình
Structured



Đuôi màu
Shade Variation



Số Face
Faces

Hygienic Tile Collection 2022

Lời mở đầu/ Introduction 02

Công nghệ Nano Bạc/ Silver Nano technology 03

04 lý do Gạch kháng khuẩn prime là sự lựa chọn tốt nhất cho gia đình bạn
04 reasons why Prime Hygienic Tiles are the best choice for your family 04

Giải pháp hoàn hảo cho không gian sống đẹp và an toàn
Perfect solution for a beautiful and safe living space 06

Body: Ceramic 08

Size 10x60 10

Size 15x80 16

Size 30x30 20

Set 30x60 26

Body: Porcelain 33

Size 60x60 34

Size 60x120 46

Size 80x80 50

Set 60x60 * 80x80 52

Body/ Xương:
Ceramic

Glaze/ Bề mặt men:
Glossy

Glaze/ Bề mặt men:
Matt

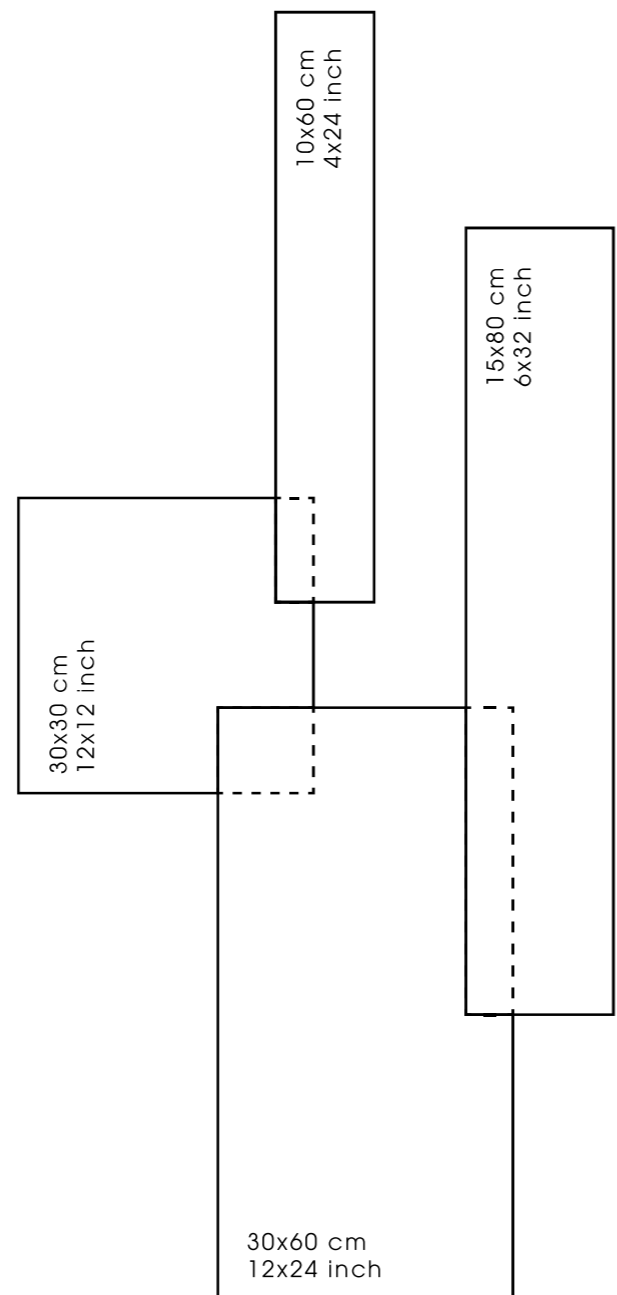

Hygienic Tile Collection 2022



CERAMIC

Code: 06.150800.20056



10x60cm



06.100600.20101

GLAZE: Matt
08 Faces



06.100600.20102

GLAZE: Matt
08 Faces



06.100600.20103

GLAZE: Matt
06 Faces



06.100600.20109

GLAZE: Matt
07 Faces



06.100600.20110

GLAZE: Matt
07 Faces



06.100600.20111

GLAZE: Matt
07 Faces



Code: **06.100600.20101**



Code: **06.100600.20102**

10

Hygienic Tile
Collection **2022**



TIÊU DIỆT ĐẾN 99,99% VI KHUẨN CÓ HẠI*
*Đối với vi khuẩn E.coli trong điều kiện kiểm nghiệm



MẪU MÃ ĐA DẠNG



TÍNH NĂNG DIỆT KHUẨN VỮNG BỀN SUỐT TUỔI THỌ**
** Phụ thuộc vào tình hình sử dụng thực tế



KHOẢN ĐẦU TƯ TỐI ƯU

11



10x60cm



06.100600.20104

GLAZE: Matt
08 Faces



06.100600.20105

GLAZE: Matt
12 Faces



06.100600.20106

GLAZE: Matt
08 Faces



06.100600.20112

GLAZE: Matt
07 Faces



06.100600.20113

GLAZE: Matt
07 Faces



Code: 06.100600.20109 - 06.100600.20110 - 06.100600.20113



Code: 06.100600.20113

12

Hygienic Tile
Collection 2022



TIÊU DIỆT ĐẾN 99,99% VI KHUẨN CÓ HẠI*
*Đối với vi khuẩn E.coli trong điều kiện kiểm nghiệm



MẪU MÃ ĐA DẠNG



TÍNH NĂNG DIỆT KHUẨN VỮNG BỀN SUỐT TUỔI THỌ**
** Phụ thuộc vào tình hình sử dụng thực tế



KHOẢN ĐẦU TƯ TỐI ƯU

13



10x60cm



06.100600.20107

GLAZE: Matt

12 Faces



06.100600.20108

GLAZE: Matt

06 Faces



Code: 06.100600.20107



Code: 06.100600.20108

14

Hygienic Tile Collection 2022



TIÊU DIỆT ĐẾN 99,99% VI KHUẨN CÓ HẠI*
*Đối với vi khuẩn E.coli trong điều kiện kiểm nghiệm



MẪU MÃ ĐA DẠNG



TÍNH NĂNG DIỆT KHUẨN VỮNG BỀN SUỐT TUỔI THỌ**
** Phụ thuộc vào tình hình sử dụng thực tế



KHOẢN ĐẦU TƯ TỐI ƯU

15



15x80cm



06.150800.20060
GLAZE: Matt
06 Faces



06.150800.20051
GLAZE: Matt
06 Faces

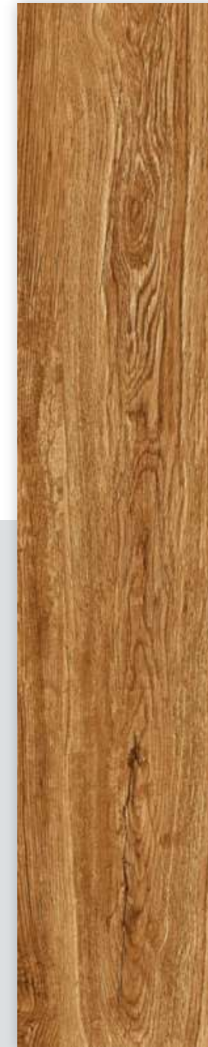

06.150800.20055
GLAZE: Matt
08 Faces



06.150800.20056
GLAZE: Matt
08 Faces



06.150800.20061
GLAZE: Matt
06 Faces



Code: 06.150800.20051

16

Hygienic Tile
Collection 2022



TIÊU DIỆT ĐẾN 99,99% VI KHUẨN CÓ HẠI*
*Đối với vi khuẩn E.coli trong điều kiện kiểm nghiệm



MẪU MÃ ĐA DẠNG



TÍNH NĂNG DIỆT KHUẨN VỮNG BỀN SUỐT TUỔI THỌ**
** Phụ thuộc vào tình hình sử dụng thực tế



KHOẢN ĐẦU TƯ TỐI ƯU

17



15x80cm

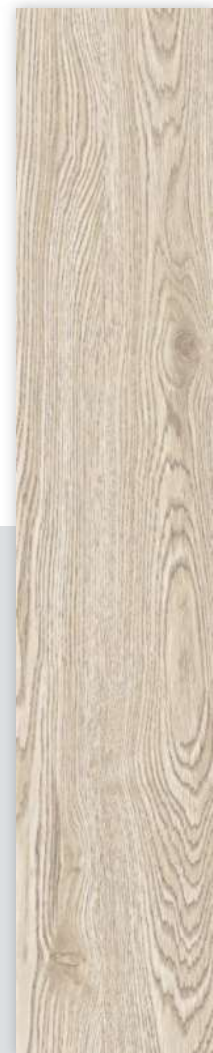

06.150800.20059
GLAZE: Matt
06 Faces



06.150800.20063
GLAZE: Matt
09 Faces

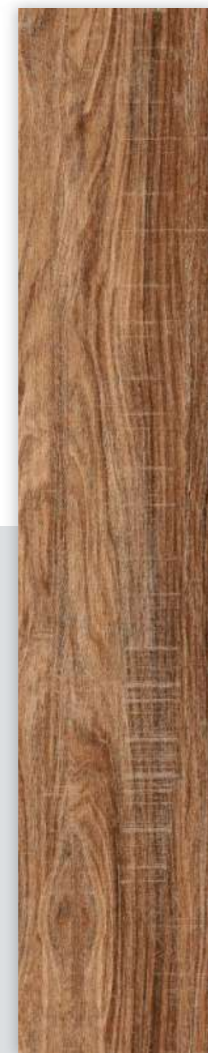

06.150800.20054
GLAZE: Matt
08 Faces



06.150800.20057
GLAZE: Matt
05 Faces

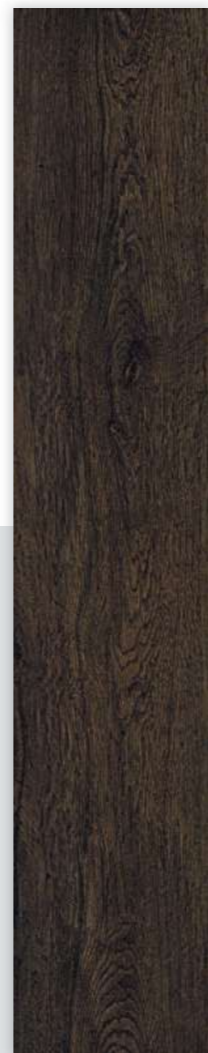

06.150800.20058
GLAZE: Matt
05 Faces



Code: 06.150800.20059





30x30cm



06.300300.20005
GLAZE: Matt
01 Face

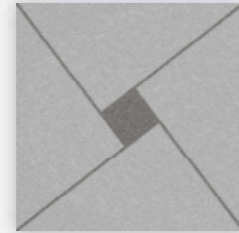

06.300300.20019
GLAZE: Matt
01 Face



05.300300.09140
GLAZE: Matt
02 Faces

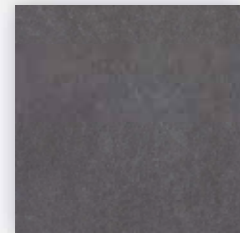

06.300300.20006
GLAZE: Matt
01 Face



06.300300.20007
GLAZE: Matt
01 Face



06.300300.20008
GLAZE: Matt
01 Face

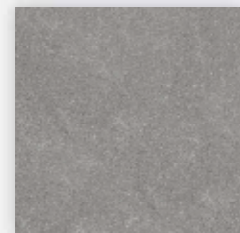

05.300300.09141
GLAZE: Matt
02 Faces

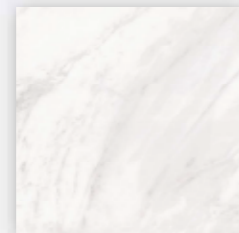

05.300300.09145
GLAZE: Matt
12 Faces

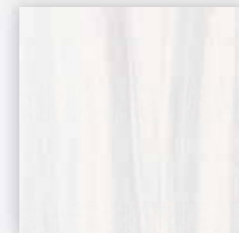

05.300300.09143
GLAZE: Matt
08 Faces



Code: 05.300300.09145

20

Hygienic Tile
Collection 2022



TIÊU DIỆT ĐẾN 99,99% VI KHUẨN CÓ HẠI*
*Đối với vi khuẩn E.coli trong điều kiện kiểm nghiệm



MẪU MÃ ĐA DẠNG



TÍNH NĂNG DIỆT KHUẨN VỮNG BỀN SUỐT TUỔI THỌ**
** Phụ thuộc vào tình hình sử dụng thực tế



KHOẢN ĐẦU TƯ TỐI ƯU

21



30x30cm



06.300300.20021
GLAZE: Matt
01 Face



06.300300.20011
GLAZE: Matt
01 Face



05.300300.09142
GLAZE: Matt
02 Faces



06.300300.20001
GLAZE: Matt
01 Face



06.300300.20020
GLAZE: Matt
01 Face



06.300300.20002
GLAZE: Matt
01 Face



06.300300.20003
GLAZE: Matt
01 Face



06.300300.20004
GLAZE: Matt
01 Face



Code: 05.300300.20001

22

Hygienic Tile
Collection 2022



TIÊU DIỆT ĐẾN 99,99% VI KHUẨN CÓ HẠI*
*Đối với vi khuẩn E.coli trong điều kiện kiểm nghiệm



MẪU MÃ ĐA DẠNG



TÍNH NĂNG DIỆT KHUẨN VỮNG BỀN SUỐT TUỔI THỌ**
** Phụ thuộc vào tình hình sử dụng thực tế



KHOẢN ĐẦU TƯ TỐI ƯU

23



30x30cm



06.300300.20013
GLAZE: Matt
01 Face



06.300300.20014
GLAZE: Matt
01 Face



06.300300.20022
GLAZE: Matt
01 Face

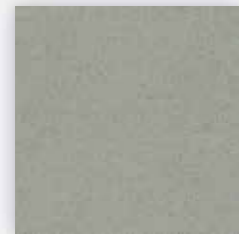

06.300300.20009
GLAZE: Matt
01 Face



06.300300.20012
GLAZE: Matt
01 Face



06.300300.20015
GLAZE: Matt
01 Face



06.300300.20016
GLAZE: Matt
01 Face



06.300300.20017
GLAZE: Matt
01 Face



06.300300.20018
GLAZE: Matt
01 Face



Code: 05.300300.20017

24

Hygienic Tile
Collection 2022



TIÊU DIỆT ĐẾN 99,99% VI KHUẨN CÓ HẠI*
*Đối với vi khuẩn E.coli trong điều kiện kiểm nghiệm



MẪU MÃ ĐA DẠNG



TÍNH NĂNG DIỆT KHUẨN VỮNG BỀN SUỐT TUỔI THỌ**
** Phụ thuộc vào tình hình sử dụng thực tế



KHOẢN ĐẦU TƯ TỐI ƯU

25



30x60cm



05.300600.20213
GLAZE: Matt
05 Faces



05.300600.20214
GLAZE: Matt
05 Faces



05.300600.20215
GLAZE: Matt
01 Face



05.300600.20217
GLAZE: Matt
01 Face



05.300600.20216
GLAZE: Matt
01 Face



05.300600.20218
GLAZE: Matt
01 Face



Code: 05.300600.20313 - 05.300600.20314 - 05.300300.20315





30x60cm

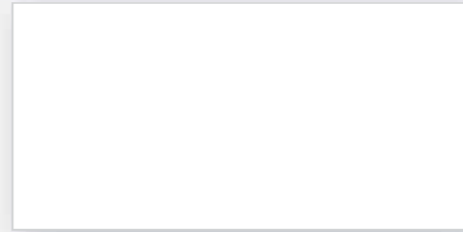

05.300600.20200

GLAZE: Glossy
01 Face



05.300600.20201

GLAZE: Glossy
04 Faces

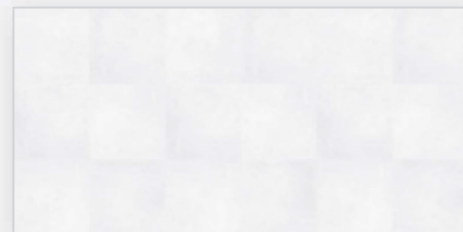

05.300600.03029

GLAZE: Glossy
01 Face



Code: 05.300600.20207 - 05.300600.20207

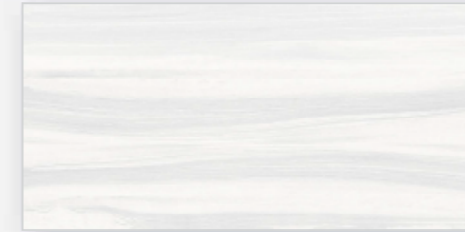

05.300600.20207

GLAZE: Glossy
07 Faces



05.300600.20208

GLAZE: Glossy
07 Faces



05.300600.20212

GLAZE: Glossy
01 Face

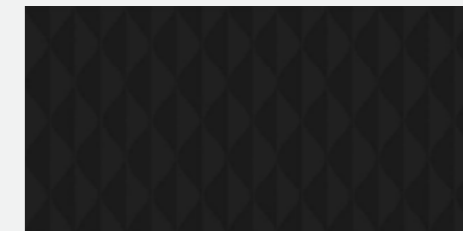

05.300600.20211

GLAZE: Glossy
01 Face



05.300600.20203

GLAZE: Glossy
24 Faces



05.300600.20204

GLAZE: Glossy
24 Faces



28

Hygienic Tile
Collection 2022



TIÊU DIỆT ĐẾN 99,99% VI KHUẨN CÓ HẠI*
*Đối với vi khuẩn E.coli trong điều kiện kiểm nghiệm



MẪU MÃ ĐA DẠNG



TÍNH NĂNG DIỆT KHUẨN VỮNG BỀN SUỐT TUỔI THỌ**
** Phụ thuộc vào tình hình sử dụng thực tế



KHOẢN ĐẦU TƯ TỐI ƯU

29



30x60cm



05.300600.20219
GLAZE: Matt
05 Faces



05.300600.20220
GLAZE: Matt
05 Faces



05.300600.20221
GLAZE: Matt
01 Face



05.300600.20209
GLAZE: Glossy
22 Faces



05.300600.20210
GLAZE: Glossy
22 Faces

05.300600.20209 - 05.300600.20210

30

Hygienic Tile
Collection 2022



TIÊU DIỆT ĐẾN 99,99% VI KHUẨN CÓ HẠI*
**Đối với vi khuẩn E.coli trong điều kiện kiểm nghiệm*



MẪU MÀ ĐA DẠNG



TÍNH NĂNG DIỆT KHUẨN VỮNG BỀN SUỐT TUỔI THỌ**
*** Phụ thuộc vào tình hình sử dụng thực tế*



KHOẢN ĐẦU TƯ TỐI ƯU

31

Body/ Xương:
Porcelain

Glaze/ Bề mặt men:
Glossy

Glaze/ Bề mặt men:
Matt

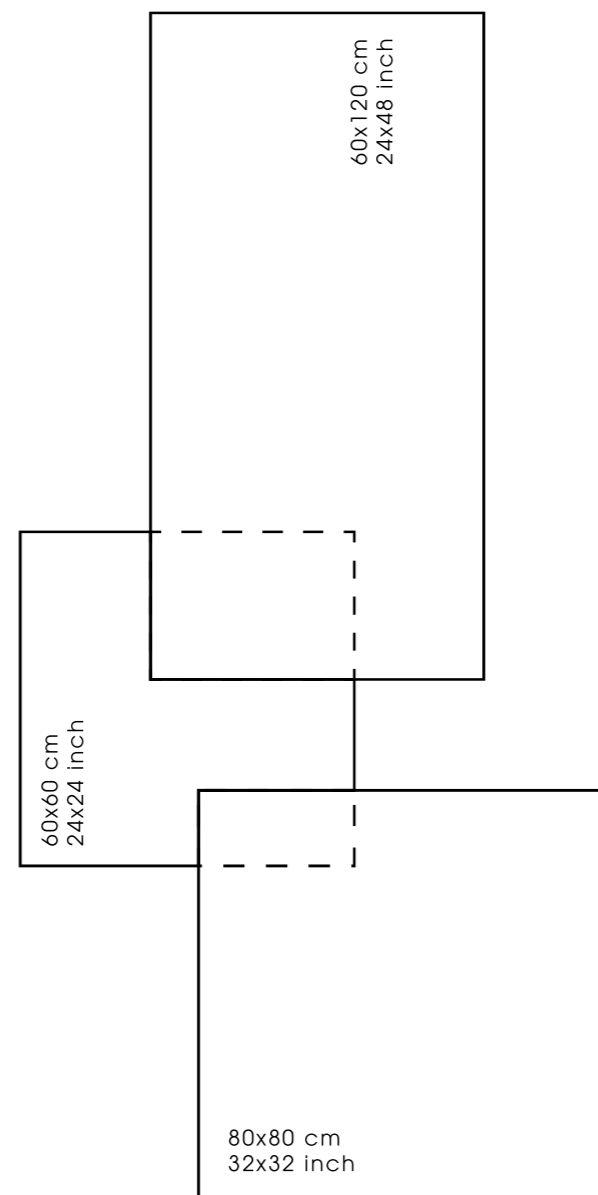

Hygienic Tile
Collection 2022



PORCELAIN

Code: 03.800800.20701



60x60cm

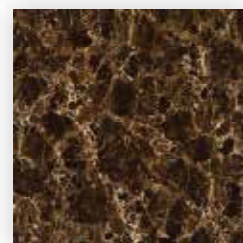

03.600600.09864

GLAZE: Glossy
01 Face



Code: 03.600600.09864

34

Hygienic Tile
Collection 2022



TIÊU DIỆT ĐẾN 99,99% VI KHUẨN CÓ HẠI*
*Đối với vi khuẩn E.coli trong điều kiện kiểm nghiệm



MẪU MÃ ĐA DẠNG



TÍNH NĂNG DIỆT KHUẨN VỮNG BỀN SUỐT TUỔI THỌ**
** Phụ thuộc vào tình hình sử dụng thực tế



KHOẢN ĐẦU TƯ TỐI ƯU

35



60x60cm

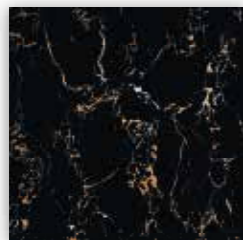

03.600600.09087

GLAZE: Glossy
04 Faces



Code: 03.600600.09087

36

Hygienic Tile
Collection 2022



TIÊU DIỆT ĐẾN 99,99% VI KHUẨN CÓ HẠI*
*Đối với vi khuẩn E.coli trong điều kiện kiểm nghiệm



MẪU MÃ ĐA DẠNG



TÍNH NĂNG DIỆT KHUẨN VỮNG BỀN SUỐT TUỔI THỌ**
** Phụ thuộc vào tình hình sử dụng thực tế



KHOẢN ĐẦU TƯ TỐI ƯU

37



60x60cm



03.600600.20850

GLAZE: Glossy
14 Faces



03.600600.20851

GLAZE: Glossy
16 Faces



Code: 03.600600.20850

38

Hygienic Tile
Collection 2022



TIÊU DIỆT ĐẾN 99,99% VI KHUẨN CÓ HẠI*
*Đối với vi khuẩn E.coli trong điều kiện kiểm nghiệm



MẪU MÃ ĐA DẠNG



TÍNH NĂNG DIỆT KHUẨN VỮNG BỀN SUỐT TUỔI THỌ**
** Phụ thuộc vào tình hình sử dụng thực tế



KHOẢN ĐẦU TƯ TỐI ƯU

39



60x60cm

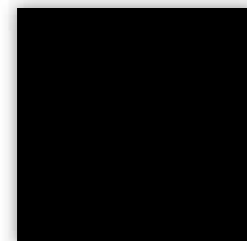

03.600600.09625

GLAZE: Glossy
01 Face

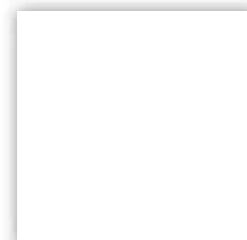

03.600600.09743

GLAZE: Glossy
01 Face



Code: 03.600600.09625 - 03.600600.09743

40

Hygienic Tile
Collection 2022



TIÊU DIỆT ĐẾN 99,99% VI KHUẨN CÓ HẠI*
*Đối với vi khuẩn E.coli trong điều kiện kiểm nghiệm



MẪU MÃ ĐA DẠNG



TÍNH NĂNG DIỆT KHUẨN VỮNG BỀN SUỐT TUỔI THỌ**
** Phụ thuộc vào tình hình sử dụng thực tế



KHOẢN ĐẦU TƯ TỐI ƯU

41



60x60cm



03.600600.09176
GLAZE: Matt
04 Faces



03.600600.09175
GLAZE: Matt
04 Faces



Code: **03.600600.09175**

42

Hygienic Tile
Collection **2022**



TIÊU DIỆT ĐẾN 99,99% VI KHUẨN CÓ HẠI*
**Đối với vi khuẩn E.coli trong điều kiện kiểm nghiệm*



MẪU MÃ ĐA DẠNG



TÍNH NĂNG DIỆT KHUẨN VỮNG BỀN SUỐT TUỔI THỌ**
*** Phụ thuộc vào tình hình sử dụng thực tế*



KHOẢN ĐẦU TƯ TỐI ƯU

43



60x60cm

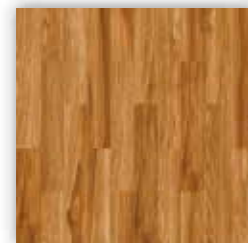

03.600600.09133
GLAZE: Matt
01 Face

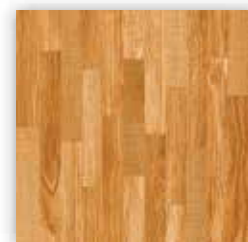

03.600600.09134
GLAZE: Matt
01 Face

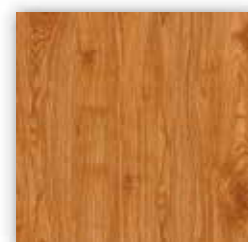

03.600600.09135
GLAZE: Matt
01 Face



Code: 03.600600.09133

44

Hygienic Tile
Collection 2022



TIÊU DIỆT ĐẾN 99,99% VI KHUẨN CÓ HẠI*
**Đối với vi khuẩn E.coli trong điều kiện kiểm nghiệm*



MẪU MÃ ĐA DẠNG



TÍNH NĂNG DIỆT KHUẨN VỮNG BỀN SUỐT TUỔI THỌ**
*** Phụ thuộc vào tình hình sử dụng thực tế*



KHOẢN ĐẦU TƯ TỐI ƯU

45



60x120cm



03.600120.20802

GLAZE: Matt

04 Faces



Code: **03.600120.20802**



03.600120.20800

GLAZE: Glossy

04 Faces



03.600120.20804

GLAZE: Glossy

08 Faces

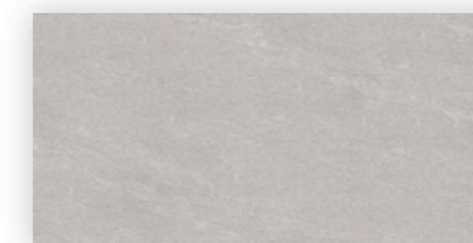

03.600120.20803

GLAZE: Glossy

06 Faces



46

Hygienic Tile
Collection **2022**



TIÊU DIỆT ĐẾN 99,99% VI KHUẨN CÓ HẠI*

**Đối với vi khuẩn E.coli trong điều kiện kiểm nghiệm*



MẪU MÃ ĐA DẠNG



TÍNH NĂNG DIỆT KHUẨN VỮNG BỀN SUỐT TUỔI THỌ**

*** Phụ thuộc vào tình hình sử dụng thực tế*



KHOẢN ĐẦU TƯ TỐI ƯU

47



60x120cm



03.600120.20801

GLAZE: Glossy
01 Face



Code: 03.600120.20801



03.600120.20805

GLAZE: Glossy
08 Faces



03.600120.20806

GLAZE: Glossy
08 Faces



03.600120.20807

GLAZE: Glossy
05 Faces



48

Hygienic Tile
Collection 2022



TIÊU DIỆT ĐẾN 99,99% VI KHUẨN CÓ HẠI*
*Đối với vi khuẩn E.coli trong điều kiện kiểm nghiệm



MẪU MÃ ĐA DẠNG



TÍNH NĂNG DIỆT KHUẨN VỮNG BỀN SUỐT TUỔI THỌ**
** Phụ thuộc vào tình hình sử dụng thực tế



KHOẢN ĐẦU TƯ TỐI ƯU

49



80x80cm



03.800800.20700
GLAZE: Matt
04 Faces



03.800800.20701
GLAZE: Matt
04 Faces



03.800800.20702
GLAZE: Matt
04 Faces



03.800800.20703
GLAZE: Matt
04 Faces



Code: 03.800800.20700- 03.800800.20702



Code: 03.800800.20702

50

Hygienic Tile
Collection 2022



TIÊU DIỆT ĐẾN 99,99% VI KHUẨN CÓ HẠI*
*Đối với vi khuẩn E.coli trong điều kiện kiểm nghiệm



MẪU MÃ ĐA DẠNG



TÍNH NĂNG DIỆT KHUẨN VỮNG BỀN SUỐT TUỔI THỌ**
** Phụ thuộc vào tình hình sử dụng thực tế



KHOẢN ĐẦU TƯ TỐI ƯU

51



60x60 * 80x80cm



60x60 cm
24x24 inch

80x80 cm
32x32 inch

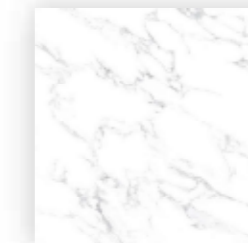

03.600600.20885
GLAZE: Glossy
04 Faces

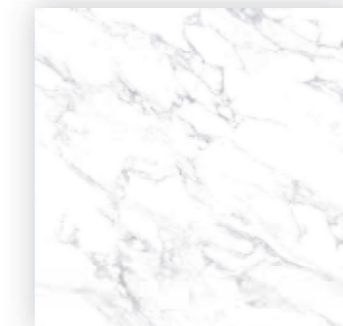

03.800800.20785
GLAZE: Glossy
04 Faces



Code: 03.800800.20785

52

Hygienic Tile
Collection 2022



TIÊU DIỆT ĐẾN 99,99% VI KHUẨN CÓ HẠI*
*Đối với vi khuẩn E.coli trong điều kiện kiểm nghiệm



MẪU MÃ ĐA DẠNG



TÍNH NĂNG DIỆT KHUẨN VỮNG BỀN SUỐT TUỔI THỌ**
** Phụ thuộc vào tình hình sử dụng thực tế



KHOẢN ĐẦU TƯ TỐI ƯU

53



60x60 * 80x80cm



Code: 03.800800.20786

60x60 cm
24x24 inch

80x80 cm
32x32 inch

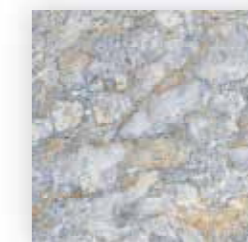

03.600600.20886

GLAZE: Glossy
04 Faces



03.800800.20786

GLAZE: Glossy
04 Faces



54

Hygienic Tile
Collection 2022



TÌEU DIỆT ĐẾN 99,99% VI KHUẨN CÓ HẠI*
*Đối với vi khuẩn E.coli trong điều kiện kiểm nghiệm



MẪU MÃ ĐA DẠNG



TÍNH NĂNG DIỆT KHUẨN VỮNG BỀN SUỐT TUỔI THỌ**
** Phụ thuộc vào tình hình sử dụng thực tế



KHOẢN ĐẦU TƯ TỐI ƯU

55



60x60 * 80x80cm



Code: 03.800800.20787

60x60 cm
24x24 inch

80x80 cm
32x32 inch



03.600600.20887

GLAZE: Glossy
04 Faces



03.800800.20787

GLAZE: Glossy
04 Faces



56

Hygienic Tile
Collection 2022



TIÊU DIỆT ĐẾN 99,99% VI KHUẨN CÓ HẠI*
*Đối với vi khuẩn E.coli trong điều kiện kiểm nghiệm



MẪU MÃ ĐA DẠNG



TÍNH NĂNG DIỆT KHUẨN VỮNG BỀN SUỐT TUỔI THỌ**
** Phụ thuộc vào tình hình sử dụng thực tế



KHOẢN ĐẦU TƯ TỐI ƯU

57

KẾT QUẢ KIỂM NGHIỆM TEST RESULTS

SGS - công ty kiểm nghiệm, kiểm tra và chứng nhận hàng đầu thế giới

Test Report 0109600
Date: 7-Feb-2022 Page 2 of 5

TEST RESULTS

Test Required: Antibacterial activity and efficacy (Quantitative) - Staphylococcus aureus ATCC 6538P and Escherichia coli ATCC 8739

Test Method: Based on JIS Z 2801:2010

Tested microorganism	Concentration of bacteria (CFU/ing)	Initial inoculum (CFU/piece of sample)	The number of bacteria recovered from control at 0 hrs. contact time (CFU/piece of sample)	The number of bacteria recovered from control at 24 hrs. contact time (CFU/piece of sample)	The number of bacteria recovered from tested sample at 24 hrs. contact time (CFU/piece of sample)	Value of antimicrobial activity (R)	%Reduction
Staphylococcus aureus ATCC 6538P	470,000	190,000 (5.3 log)	190,000 (5.3 log)	370,000 (5.6 log)	2,100 (3.3 log)	2.3	98.89
Escherichia coli ATCC 8739	450,000	180,000 (5.3 log)	180,000 (5.3 log)	5,300,000 (6.7 log)	Less than 10 (<-1.0 log)	>5.7	>99.99

Remark:
1. The % Reduction is calculated based on customer's requirement.
2. % Reduction = (A-B)/A * 100
where:
A = The number of bacteria recovered from control at 0 hrs. contact time (CFU/piece of sample)
B = The number of bacteria recovered from tested sample at 24 hrs. contact time (CFU/piece of sample)
3. R = (Li - Uo) - (Ai - Uo) = Li - Ai

Where: R : antibacterial activity
Uo : average of logarithm numbers of viable bacteria immediately after inoculation on untreated test piece
Li : average of logarithm numbers of viable bacteria after inoculation on untreated test piece after 24 h
Ai : average of logarithm numbers of viable bacteria after inoculation on antibacterial test piece after 24 h
Criteria : The value of antimicrobial activity obtained by the testing methods of this standard shall not be less than 2.0

*Any holder of this document is advised that should client or third party information be supplied with respect to the goods or sample, SGS may, at its discretion, attached or indicate such information to the report but SGS makes no warranties or accepts no liability for the validity or lack thereof of such information.

SGS (Thailand) Limited | Laboratory Services 41/23 Soi Panna 11 25 Panna 18 Road, Chongnonsi, Yankasak, Bangkok 10130
t: +66-02-583 85 41 254 74 85 93 f: +66-02-254 74 94 653 07 58 www.sgs.com

Ngày cấp kết quả kiểm nghiệm:
07/02/2022

Thí nghiệm được thực hiện trên bề mặt Gạch kháng khuẩn Prime với 2 loại vi khuẩn: E.Coli và Tụ cầu vàng

Phương pháp kiểm nghiệm tuân theo tiêu chuẩn quốc tế JIS Z 2801:2010

Kết quả với vi khuẩn Tụ cầu vàng: Giảm 98.89% lượng vi khuẩn trên bề mặt gạch sau 24h

Kết quả với vi khuẩn E.Coli: Giảm hơn 99.99% lượng vi khuẩn trên bề mặt gạch sau 24h





TRỤ SỞ CHÍNH

HEAD OFFICE

KCN Bình Xuyên, TT. Hương Canh, H. Bình Xuyên, T. Vĩnh Phúc

T: +84 211 3888 987 | **F:** +84 211 3888 986

E: info@prime.vn

VĂN PHÒNG ĐẠI DIỆN PRIME MIỀN TRUNG

DA NANG OFFICE

76 Võ Chí Công, P. Hòa Xuân, Q. Cẩm Lệ, TP. Đà Nẵng

T: +84 2366 519 288 | **F:** +84 2366 519 289

E: info@prime.vn

VĂN PHÒNG ĐẠI DIỆN PRIME MIỀN NAM

HO CHI MINH OFFICE

63-65 Nguyễn Thế Truyen, P. Tân Sơn Nhì, Q. Tân Phú, TP. Hồ Chí Minh

T: +84 286 675 0011 | **F:** +84 286 675 0022

E: info@prime.vn